



# Series 103 Differential Pressure Switch

## General Instructions

These instructions provide information for installation, electrical connection, process connection and calibration of Series 103 Differential Pressure Switches.

Process pressure is sensed by a diaphragm and piston assembly. The piston responds to differential pressure and moves a lever that is connected to a torsionally stiff cross shaft. One end of the cross shaft is connected to a lever that is biased by the range spring. The other end has a lever that actuates (deactuates) an electrical switching element.

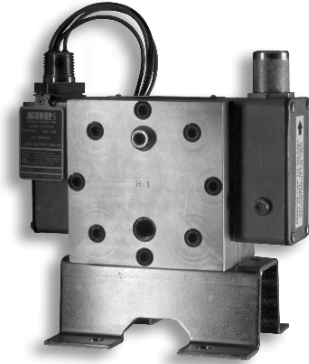
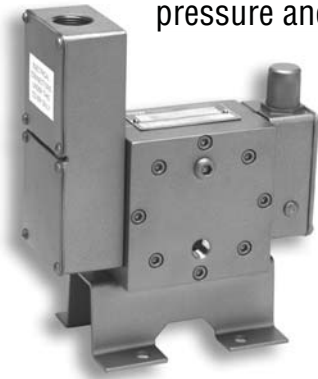

**NOTE: If you suspect that a product is defective, contact the factory or the SOR Representative in your area for a return authorization number. This product should only be installed by trained and competent personnel.**

*Design and specifications are subject to change without notice.*

*For latest revision, go to [www.sorinc.com](http://www.sorinc.com)*

### Table of Contents

Installation .....	1
Installation .....	2
Process Connection .....	2
Electrical Connection.....	3
Special Conditions.....	4
Calibration .....	5
Dimensions Series 103-212.....	6
Dimensions Series 103-502, 805 .....	8
ATEX Information .....	10
Declaration of Conformity .....	11

## Installation

This product should only be installed by trained and competent personnel.

Securely mount the pipe kit bracket or base plate as supplied to horizontal member of pipe stanchion, channel rack or flat surface using suitable bolts. The 103 is not position sensitive. It may be mounted in any position.



**Use care during installation. Do not inadvertently move the electrical switching element or its housing. Movement of either could disturb the relative positions of internal working parts and alter calibration or render the device inoperative.**

## Safety Integrity Level (SIL) Installation Requirements

The SOR pressure switches have been evaluated as Type-A safety related hardware. To meet the necessary installation requirements for the SIL system, the following information must be utilized:

- Proof Test Interval shall be one year.
- Units may only be installed for use in Low Demand Mode.
- Products have a HFT (Hardware Fault Tolerance) of 0, and were evaluated in a 1oo1 (one out of one) configuration.

Form 1538 (03.12) ©2012 SOR Inc.

## Series 103 Differential Pressure Switch Diagrams

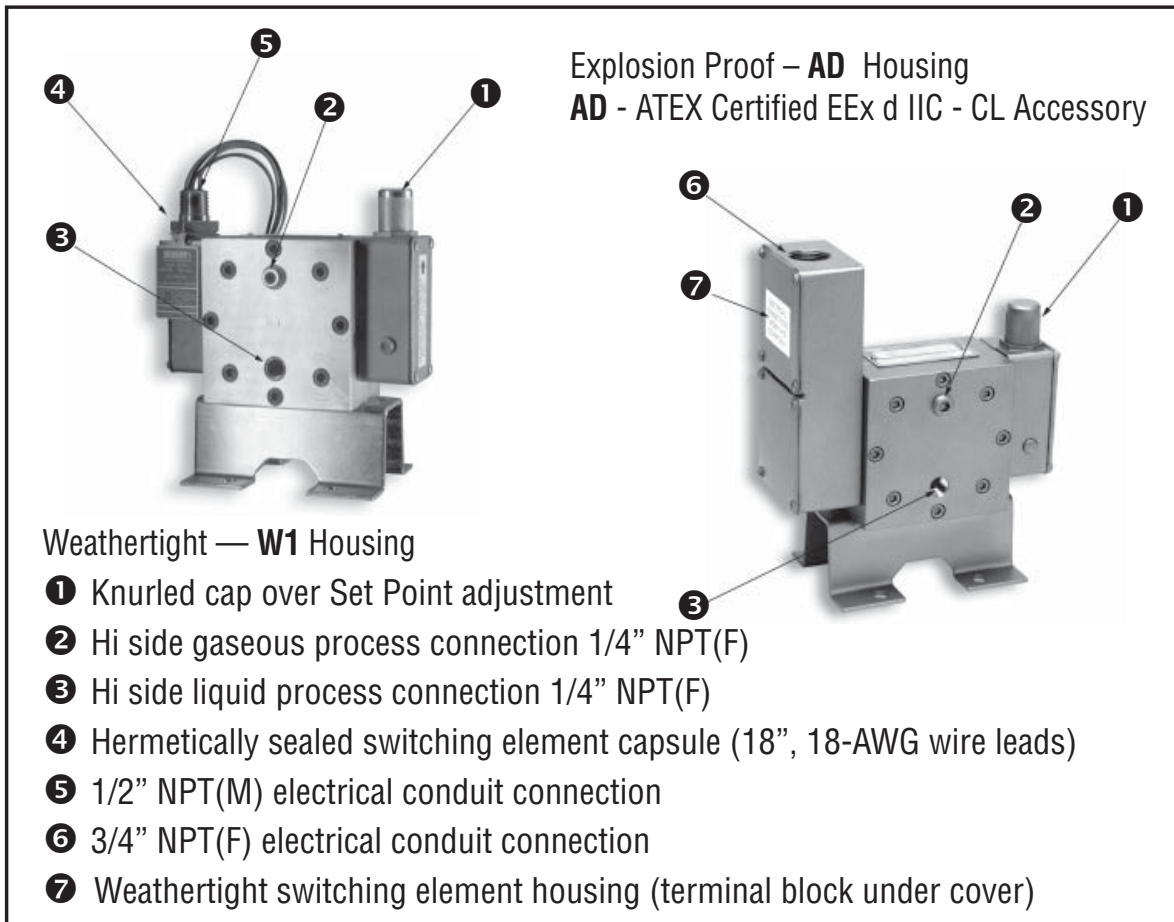

## Process Connection

The high pressure side (marked Hi) has two 1/4" NPT(F) process connections. The low pressure side (marked Lo) also has two 1/4" NPT(F) process connections. For optimum performance, bleed the air or liquid from the switch with ports aligned vertically before placing the switch into service.

Connect the liquid process to the lower ports to bleed gasses from the switch. Connect the gaseous process to the upper ports to bleed liquid from the switch. The switch may then be oriented in any position for switching.

When the process has entrained particles or is considered dirty, both upper and lower connections may be used to create a flushing system to prevent buildup against the diaphragm/piston assembly. Should a pair of process connections be plugged, ensure that plugs are tightened for a leak-free fit.

## Electrical Connection

**Weathertight Models:** Interrupt electrical power. Remove the top cover plate. Terminal block is standard. The insulation is marked C - Common, NO - Normally Open, NC - Normally Closed and G - Ground (earth) when applicable.

**Explosion-Proof Models:** Hermetically sealed switching element capsule has 18", 18-AWG wire leads color coded and marked C - Common, NO - Normally Open, NC - Normally Closed and G - Ground (earth) when applicable. (See schematic.)

### Wiring Lead Code Colors

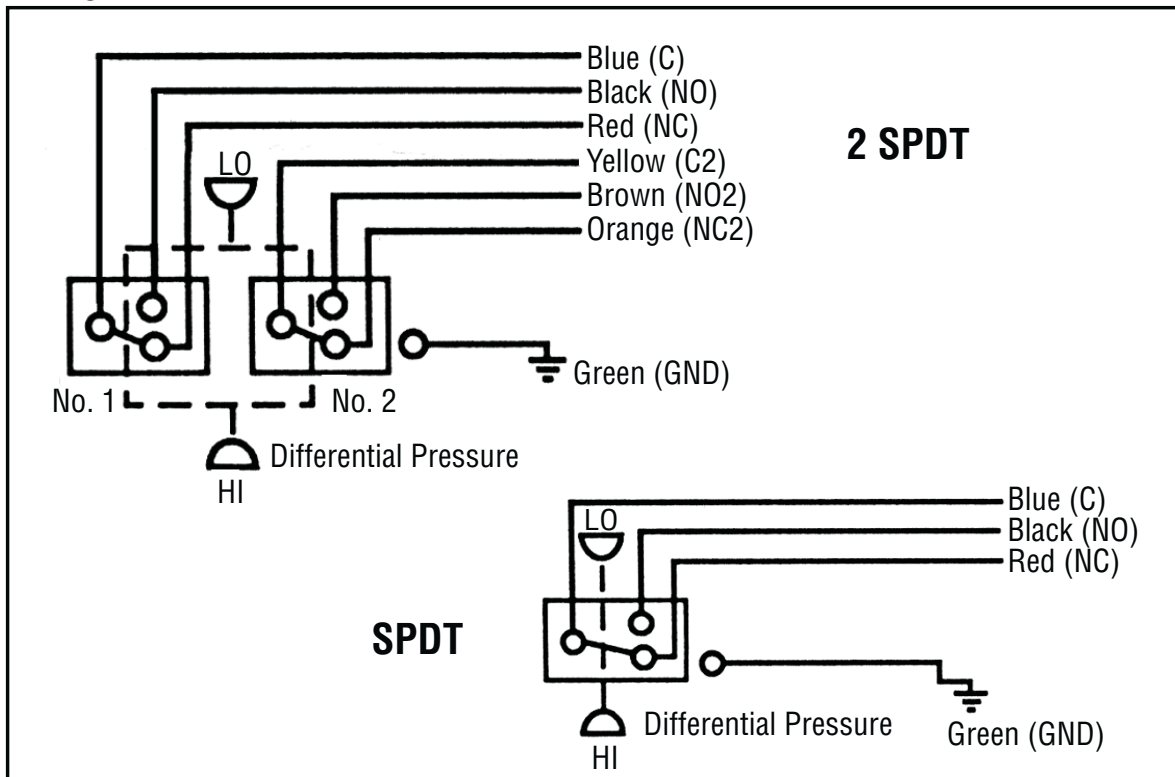

Ensure that the wiring conforms to all applicable local and national electrical codes and install unit(s) according to relevant national and local safety codes.

## Special Conditions for Safe Use ATEX

- The terminal box to which the equipment is attached must, together with the switch, ensure the requisite thread engagement for Apparatus Group IIC.  
**AD Housing:** ATEX Approved junction box required.
- The permanently attached cables must be suitably terminated and protected from impact.
- When the switch is attached to an increased safety terminal box, the assembly must be capable of withstanding the impact test specified in BS 5501: Part 1: 1997.
- The sealing arrangements must maintain the minimum IP54 rating required by the increased safety enclosure.
- The switch must attach to the enclosure using an existing entry.
- The apparatus may have a combined nameplate which carries multiple approvals (Intrinsic Safety & Flameproof). The equipment should be marked as to which protection method it is installed as, and shall not be changed or utilized in any other manner than was originally marked by the end user.
- To minimize the risk of electrostatic discharge, clean only with a damp cloth.

***NOTE: These circuits are all part of the same IS circuit meeting the requirement of 30V max and 1A max. You cannot connect a zener barrier to C/NO/NC circuit and another barrier to C2/NO2/NC2 circuit unless the combination of the two barriers is intrinsically safe and is less than 30V and 1A.***

***NOTE: For IS, there must be no connection to GND if the switch circuit is connected to a shunt zener diode safety barrier.***

## Calibration

### Coarse Calibration

Device calibrated without reference to system (static) pressure (Lo side vented). Test apparatus:

- Pressure gauge
- Variable pressure source
- Test light or ohmmeter

- ① Remove weathertight knurled cap.
- ② Insert a 5/32 Allen hex wrench into Set Point adjustment.
- ③ Connect a test light or ohmmeter to C – Common and NO – Normally Open. W1 - Terminal block is accessible under noted cover. AD - This model supplied with color coded and marked wire leads.
- ④ Increase pressure to the desired Set Point on Increasing pressure.
- ⑤ Turn the hex wrench clockwise (in) to increase Set Point and counterclockwise (out) to decrease Set Point. Note the actuation, deactuation by test light or ohmmeter.
- ⑥ For Set Point on Decreasing pressure, decrease pressure to the desired Set Point and repeat Step 5.
- ⑦ Remove the hex wrench and replace weathertight cap.

### Precise Calibration

The device is calibrated with reference to system (static) pressure. Performance is enhanced when calibration is accomplished under simulated system pressure profile or as it is intended to be used in actual service. Test apparatus:

- Differential pressure gauge
- Variable pressure source
- Block/bleed and equalizer valves
- Test light or ohmmeter

- ① Remove the weathertight knurled cap.
- ② Insert 5/32 Allen hex wrench into Set Point adjustment.
- ③ Connect test light or ohmmeter to C–Common and NO – Normally Open. W1 - Terminal block is accessible under noted cover. AD - This model supplied with color coded and marked wire leads.
- ④ Increase pressure equally on Hi and Lo sides to desired system (static) operating pressure (equalizer valve open).
- ⑤ To adjust Set Point on Increasing Differential Pressure: Close equalizer valve and bleed Lo side until desired pressure appears on indicator and Set Point is verified by test light or ohmmeter. Turn hex wrench clockwise to increase Set Point and counterclockwise to decrease Set Point. Note actuation, deactuation by test light or ohmmeter.
- ⑥ To adjust Set Point on Decreasing Differential Pressure: Differential Pressure must be at or above Increasing Set Point, then slightly open equalizer valve until desired decreasing pressure appears on indicator and Set Point is verified by test light or ohmmeter. Perform Step 5 above as necessary.
- ⑦ Remove Allen wrench and replace weathertight cap.



***Do not remove other covers or attempt to adjust other parts of the mechanism. All have been precisely positioned at the factory and should not be moved in the field.***

# Dimensions — Series 103-212

Dimensions in this literature are for reference only. Contact the factory for certified drawings for a particular model number.

## W1 Non-Hazardous Service (Weathertight)

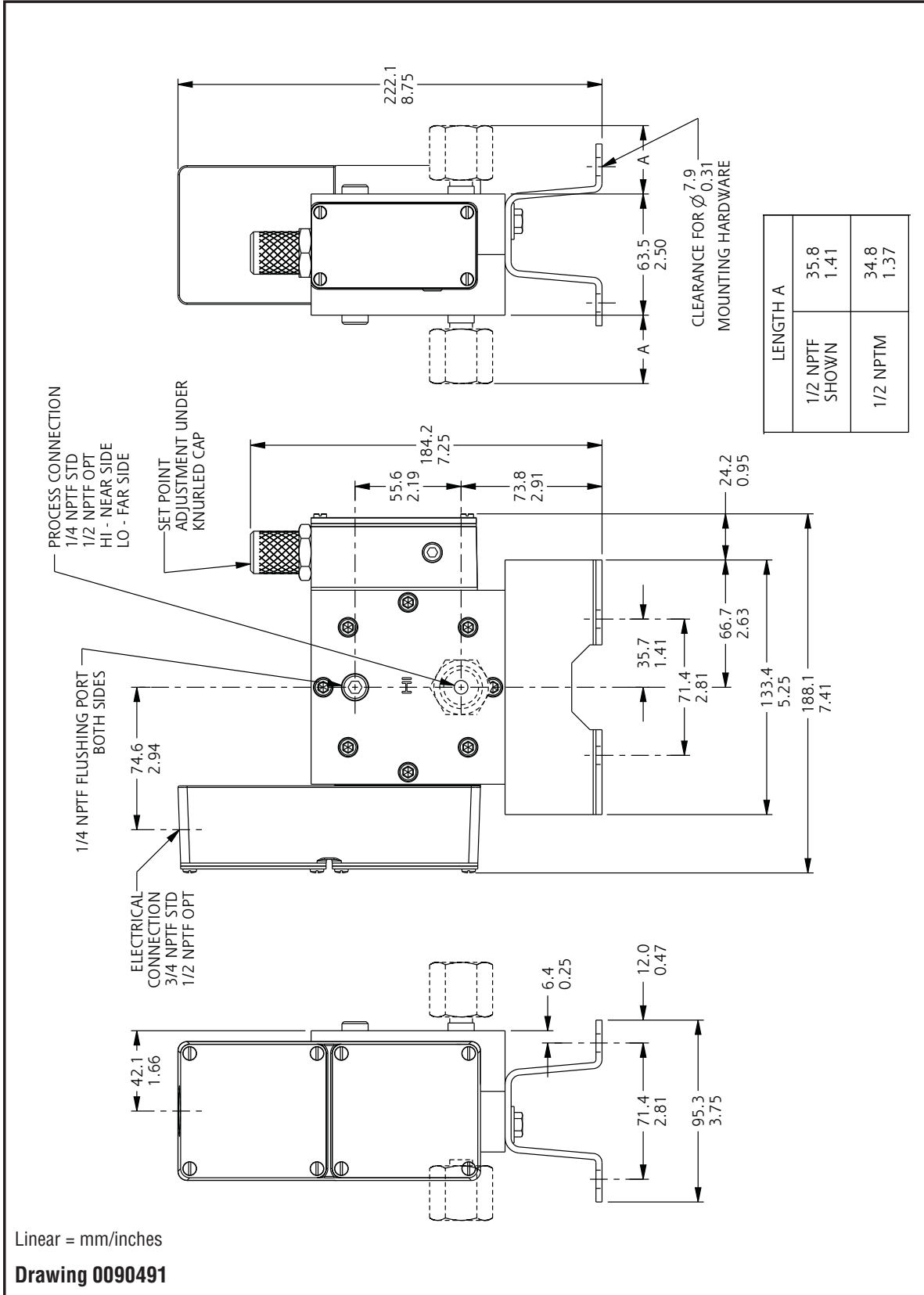

Linear = mm/inches

Drawing 0090491

## AD Hazardous Service (Weathertight)

(AS & JS dimensions are the same as AD except the required junction box is not shown because of the dimensional and design variances between manufacturers of approved junction boxes.)

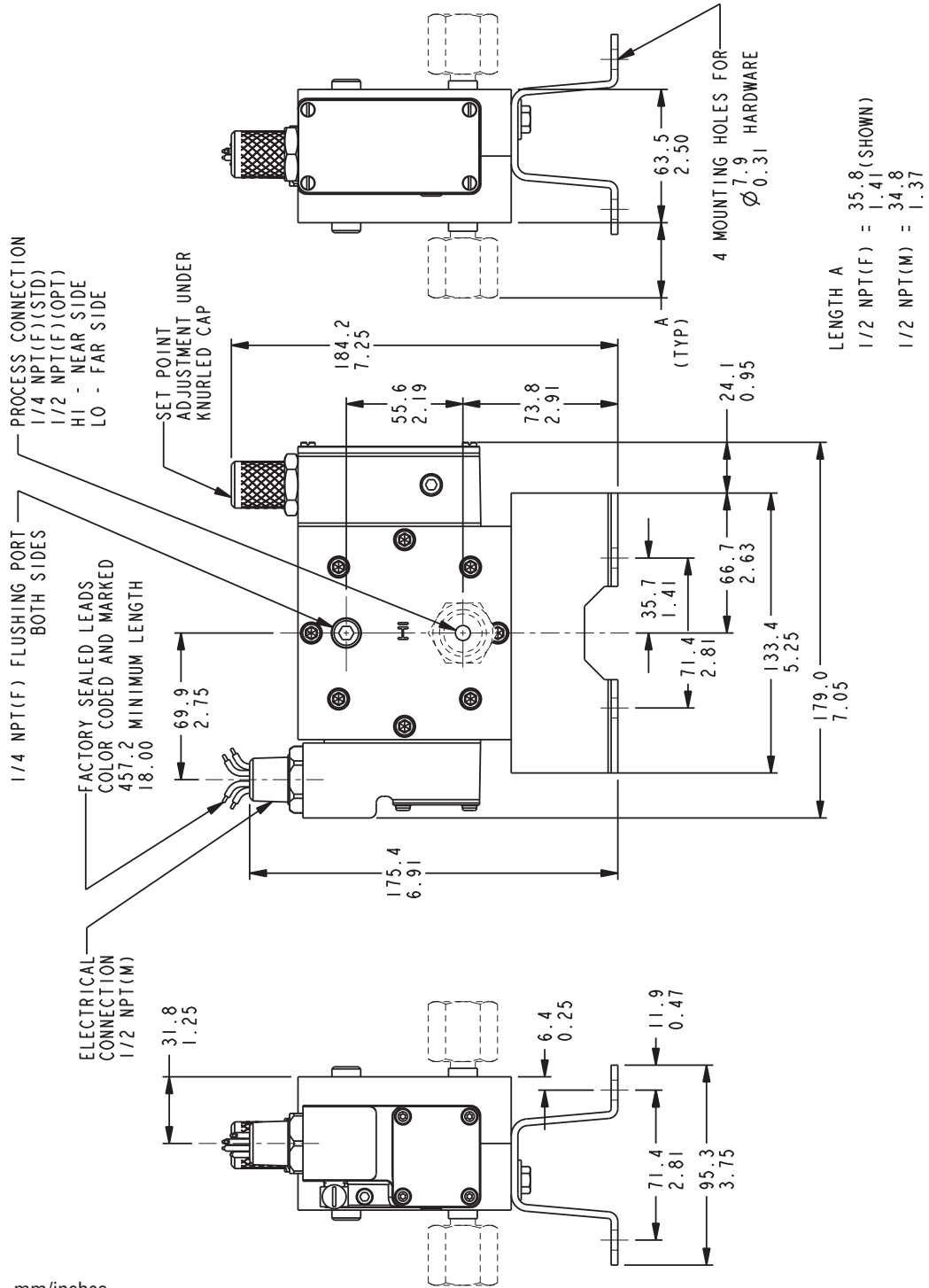

Linear = mm/inches

Drawing 0090493

# Dimensions — Series 103-502, 805

Dimensions in this catalog are for reference only. Contact the factory for certified drawings for a particular model number.

## W1 Non-Hazardous Service (Weathertight)

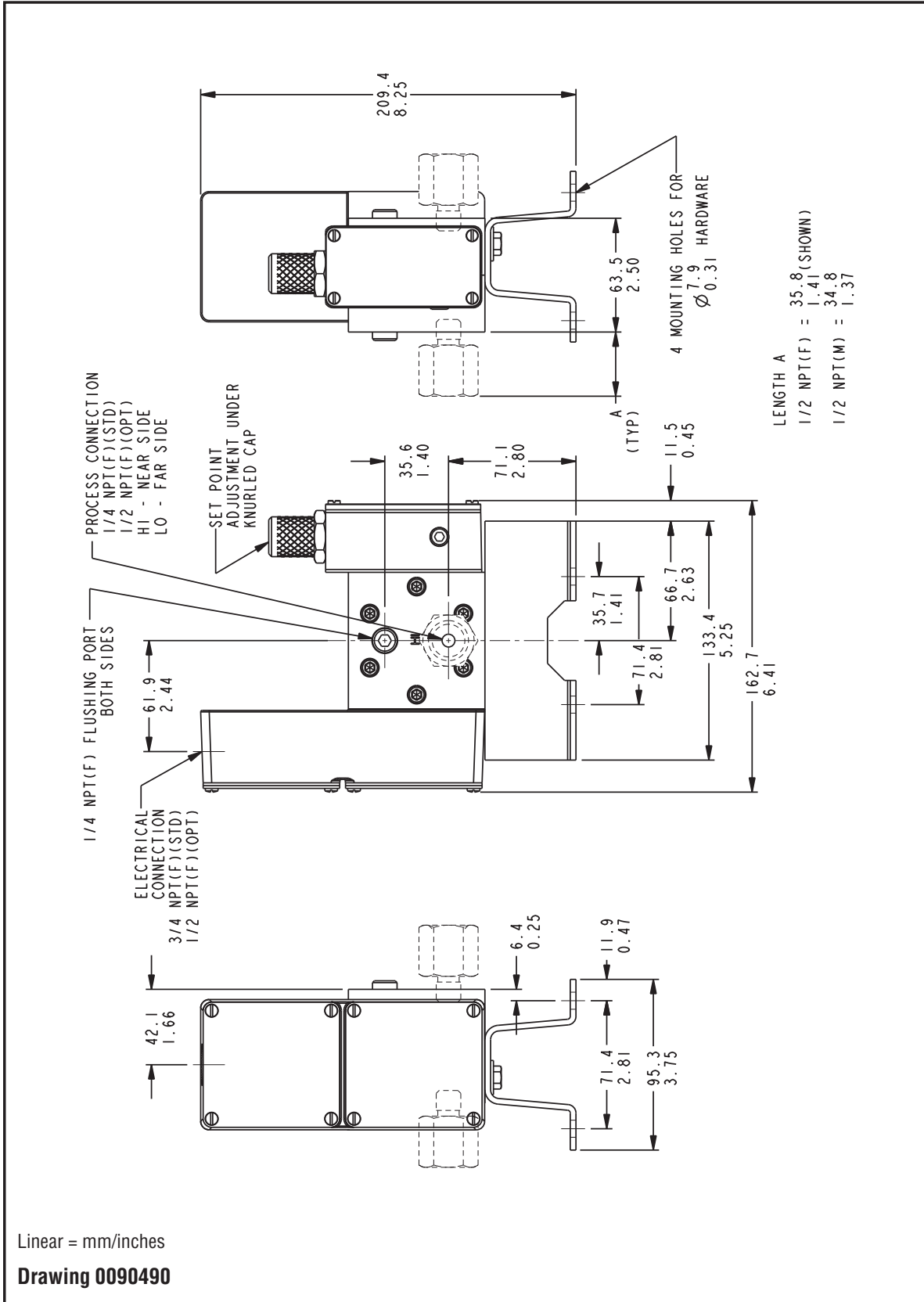

# AD Hazardous Service (Weathertight)

LENGTH A	
1/2 NPTF SHOWN	35.8 1.41
1/2 NPTM	34.8 1.37

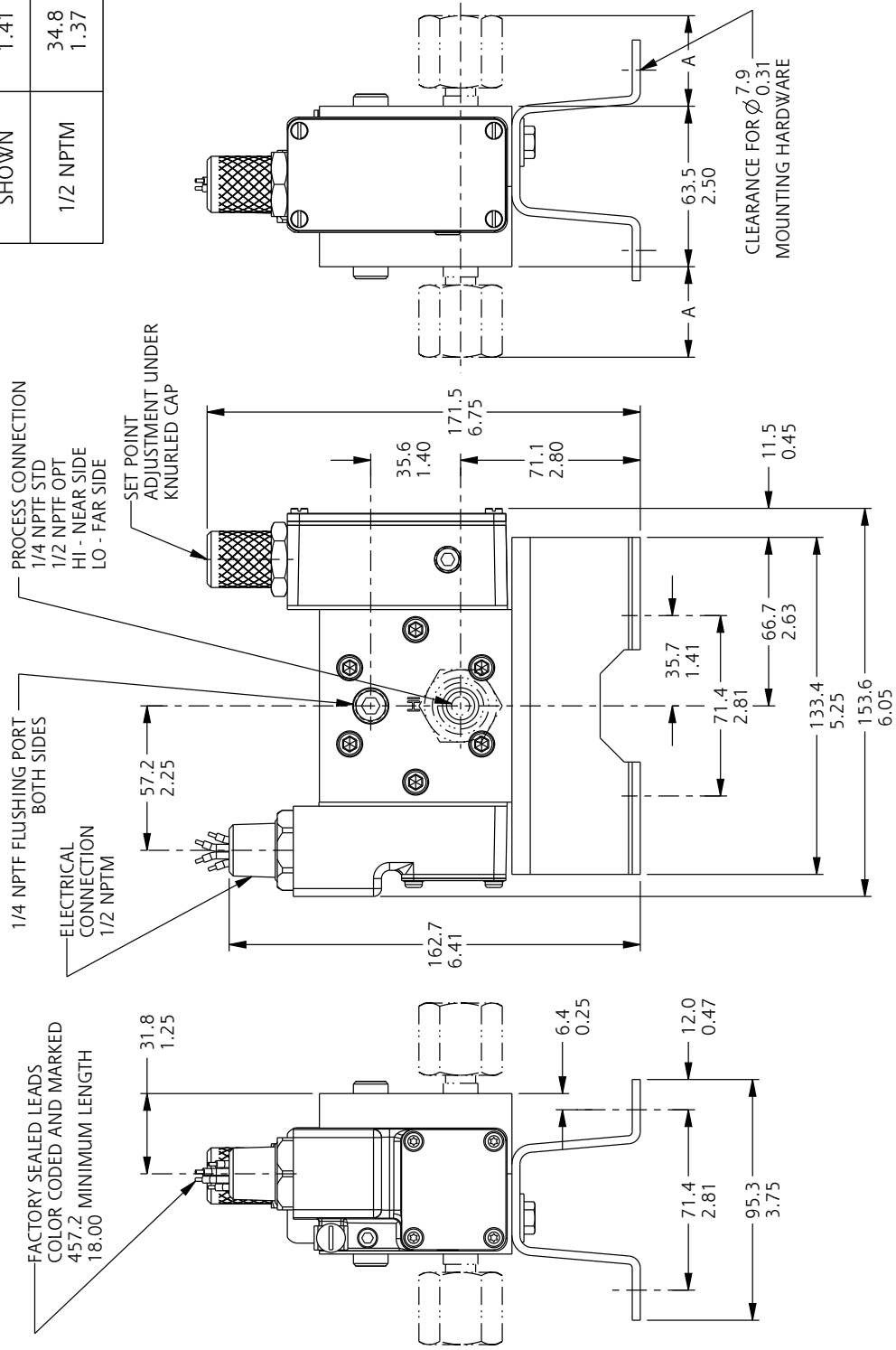

Linear = mm/inches

**Drawing 0090492**

## General Information for ATEX-Certified Models

Piston-Spring Designators	Adjustable Range Increasing Differential Pressure		Maximum System Pressure		Maximum Differential Pressure	
	psid (in. wcd)	bar [mbar]	psi	bar	psi	bar
103 - 212	(7 to 100)	[18 to 250]	1500	100	1500	100
103 - 502	(20 to 150)	[50 to 375]	3000	210		
103 - 805	(100 to 1000)	[250 to 2500]				
Designator	AC Rating		DC Rating			
	Volts	Amps	Volts	Amps	Volts	Amps
AF & AG	250	11	125	0.5	30	5
EF & EG	250	5	125	0.5	30	5
JF & JG	125	1	---	---	30	1

### Sample Nameplate

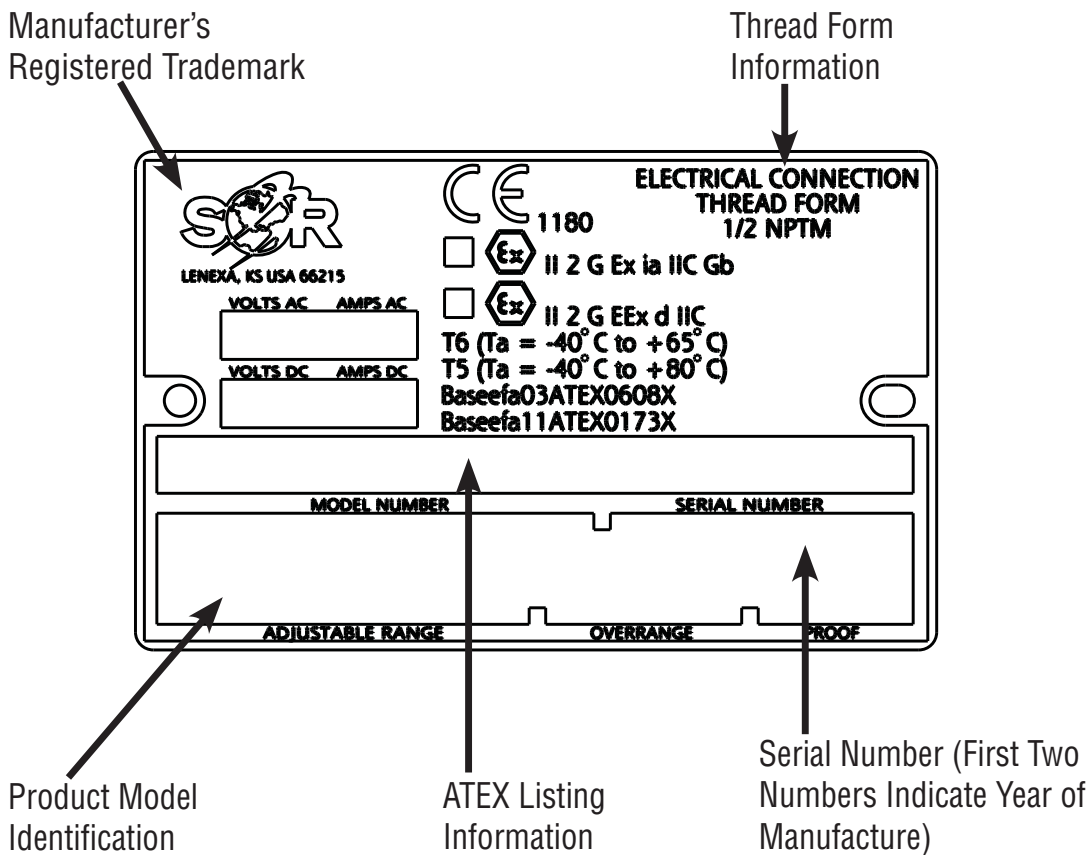

Drawing 8304205

# Declaration of Conformity

For ATEX Certified Models



## EC Declaration of Conformity



<b>Product</b>	<b>A Series 102 or 103 Differential Pressure Switch</b>
<b>Manufacturer</b>	SOR Inc. 14685 West 105 <sup>th</sup> Street, Lenexa, Kansas 66215-5964 United States of America
<b>Date of Issue</b>	<b>March 30, 2012</b>
<b>We declare that the above products conform to the following specifications and directives</b>	ATEX Directive (94/9/EC) Equipment Intended for use in Potentially Explosive Atmospheres EN 60079-0:2004 EN 50014:1997 + Amds. 1 and 2 IEC 60079-0: 2011
<b>Carries the marking</b>	<b>II 2 G EEx d IIC T6</b> (Tamb = -40°C to +65°C) <b>EEx d IIC T5</b> (Tamb = -40°C to +80°C) <b>Ex ia IIC T5 Gb</b> (-40°C ≤ Ta ≤ +80°C) <b>Ex ia IIC T6 Gb</b> (-40°C ≤ Ta ≤ +65°C)
<b>Reference document</b>	<b>EC-Type Examination Certificates</b> <b>Baseefa03ATEX0608X</b> , Issued October 31, 2003 <b>Baseefa11ATEX0173X</b> , Issued March 28, 2012
<b>ATEX Notified Body</b>	<b>Baseefa (2001) Ltd.</b> (Notified Body No. 1180) Rockhead Business Park, Staden Lane, Buxton, Derbyshire SK17 9RZ United Kingdom  Baseefa Customer Reference No. 1021
<b>Person responsible</b>	John J. Fortino (VP of Engineering)

John J. Fortino

WE DELIVER QUALITY ON TIME



14685 West 105th Street, Lenexa, KS 66215-2003  
913-888-2630 • 800-676-6794 USA • 913-888-0767 FAX

Process Instrumentation | LEVEL | PRESSURE | FLOW | TEMPERATURE

Form 1383 (04.12) ©2012 SOR Inc. (Printed in USA)



Printed in USA

[www.sorinc.com](http://www.sorinc.com)

---

14685 West 105th Street, Lenexa, KS 66215 ■ 913-888-2630 ■ 800-676-6794 USA ■ Fax 913-888-0767

---

**12/12** Registered Quality System to ISO 9001:2008

Form 391 (05.12) ©2012 SOR Inc.