

General Instructions

These instructions provide information for installation, electrical connection, process connection and calibration of Series 101/121 Differential Pressure Switches.

B-Series models (B3, B4, B5, B6) may be ATEX /IECEX Approved with the addition of a CL or ML option at the end of the model string. Specific information and instructions concerning these models will be found throughout the following pages.

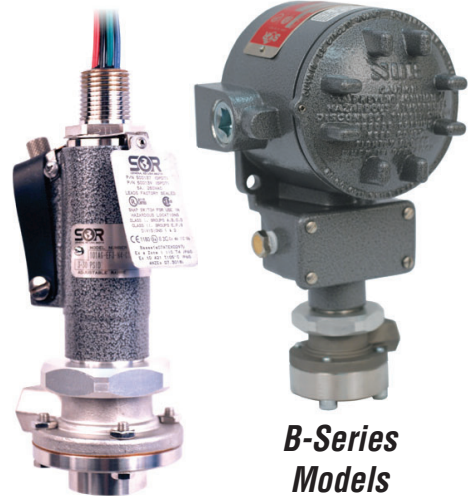

**Mini-Hermet
Models**

**B-Series
Models**



**General Purpose and
Weathertight Models**

Principle of Operation

Process pressure is sensed by a diaphragm and piston assembly. The piston responds to differential pressure and moves a shaft that actuates (deactuates) an electrical switching element. Low side pressure and an adjustable range spring oppose high side pressure. Adjustment of the range spring determines the set point. (See Calibration.)



Use care during installation to avoid moving the electrical switching element or its housing. Movement of either could change calibration or render the device inoperative.

NOTE: If you suspect that a product is defective, contact the factory or the SOR® Representative in your area for a return authorization number (RMA). This product should only be installed by trained and competent personnel.

Table of Contents

Design and specifications are subject to change without notice.

*For latest revision, go to
SORInc.com*

Installation	2
SIL Installation	2
Process Connection	2
Electrical Connection	3
Calibration	4-6
ATEX/IECEX Marking Information	9
Declaration of Conformity	10

Installation

This product should only be installed by trained and competent personnel.

- 1 Secure the housing to a bulkhead, panel rack or pipe stanchion with suitable bolts.



When bolting housings with integral mounting pads to irregular or uneven surfaces, install rubber washers between the housing and the mounting surface to prevent deformation of the housing.



Failure to mount the housing on a flat mounting surface may result in torsional forces on the housing that could cause false trips or render the pressure switch inoperative.

- 2 Line mounting by either process connection or electrical conduit connection is not recommended for housings with integral mounting pads.
- 3 Suggested mounting orientation is high side process pressure port at 6 o'clock. However, the device can be mounted in any position. Optional breather drains should be positioned to allow moisture to escape from the housing interior. *Breather drains must be kept clear of paint and foreign matter.*



For B-Series Housings: One vent hole should be fitted with a suitable breather to maintain weathertight rating NEMA4, 4X, IP65 or vented to a safe area. Piping should be minimum 1/4" diameter and maximum 5 meters long (based on process fluid SG 1.0). The other vent hole may be plugged.

Safety Integrity Level (SIL) Installation Requirements

The SOR pressure switches have been evaluated as Type-A safety related hardware. To meet the necessary installation requirements for the SIL system, the following information must be utilized:

- Proof Test Interval shall be one year.
- Units may only be installed for use in Low Demand Mode.
- Products have a HFT (Hardware Fault Tolerance) of 0, and were evaluated in a 1001 (one out of one) configuration.

Form 1538 (03.12) ©2012 SOR Inc.

Process Connection

Connect the process lines to the pressure ports using two wrenches: one to hold the hex flats on the pressure port, the other to tighten the process pipe or tube fitting. The high pressure side (stamped HI) and the low pressure side (stamped LO) have 1/4" NPT(F) or 1/4" BSP(F) process connections as standard.



Rigid process piping must be arranged to minimize bending or twisting forces which could disturb the positioning of internal parts and change calibration or render the device inoperative after installation. Use care to avoid loosening the pressure port from the body or the body from the electrical housing.

Electrical Connection

Ensure that wiring conforms to all applicable local and national electrical codes and install unit(s) according to relevant national and local safety codes.

NOTE: For B-Series ATEX/IECEx Certified Models: Electrical conduit connection threads may be of non-ISO thread form. Check the product nametag for relevant thread form information before attempting to connect to the electrical conduit connection. In the event a fitting is used, check the adaptor body for thread size information.



Electrical Power must be disconnected from explosion proof models before the cover is removed. Failure to do so could result in severe personal injury or substantial property damage.

When making electrical connections, use care to avoid movement of the electrical switching element. Electrical connections are either screw terminals, terminal blocks or 18-gauge, 18-inch wire leads.

Screw terminal and terminal block points are identified on the insulation card inside the electrical housing. Refer below for wire lead color codes.

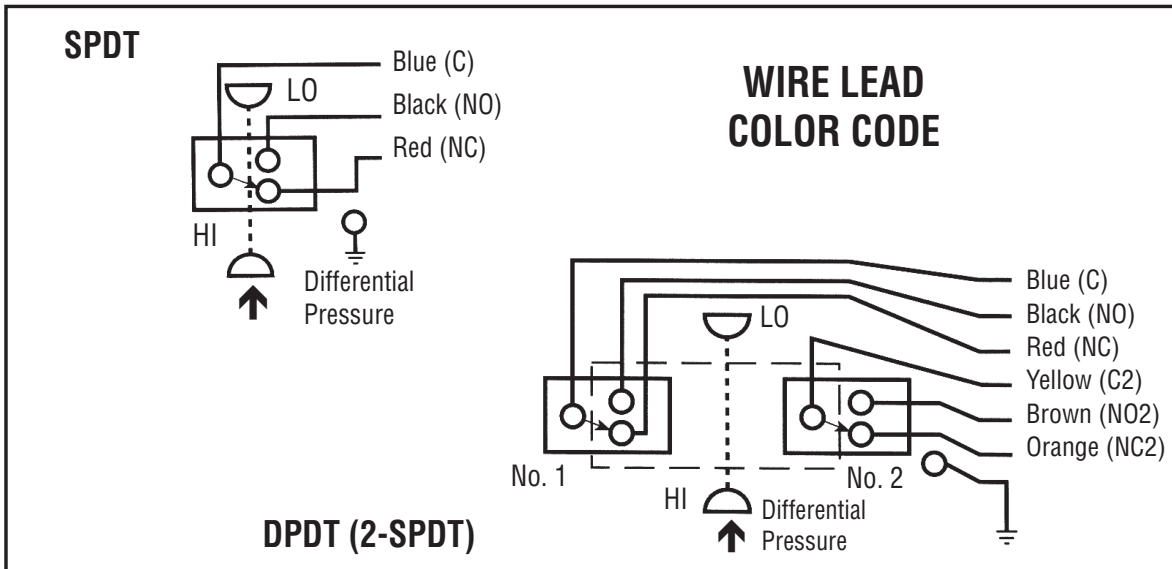

NOTE: Storing excess wire or making wire lead splices inside the pressure switch housing should not be done and may interfere with the pressure switch operation.

Calibration

Mini-Hermet models: Remove the weathertight cap. Use a 1/8" hex Allen wrench to turn the adjusting screw to the desired set point. Turn the adjusting screw clockwise (in) to increase the set point and counterclockwise (out) to decrease the set point. Use either the coarse or the precise set point calibration procedure.



Do not unthread the adjusting screw more than two threads below the flush point of housing as calibration could be adversely affected.

All Other Models: Use a 3/4-inch open-end wrench to turn hex adjusting nut clockwise to increase set point, and counterclockwise to decrease set point. An approximate set point can be obtained by sighting across top of adjusting nut to the calibration scale on the interior wall of the housing. If coarse or precise set point calibration is required, calibrate according to the appropriate procedure.



For B-Series Housings: The electrical compartment cover must remain sealed and the Allen locking screw tightened at all times to prevent removal of the cover while the pressure switch is in service. Removal of the cover while the pressure switch is in service in a hazardous location could result in severe personal injury or substantial property damage.

Coarse Calibration Procedure:

- 1 Connect variable pressure source to test gauge and HI side pressure port.
- 2 Connect test light or ohmmeter across C – Common and NO – Normally Open switching element contacts.
- 3 Raise pressure and note test gauge reading when circuit closes.
- 4 Slowly drop pressure and note test gauge reading when circuit opens.
- 5 Turn set point adjustment clockwise to increase set point, or counterclockwise to decrease set point.
- 6 Repeat Steps 3, 4 and 5 until contacts change at desired increasing or decreasing differential pressure set point.

Precise Calibration Procedure: The precise calibration procedure references system (static) pressure. Set point accuracy is enhanced by calibrating the differential pressure switch under simulated service pressure conditions.

The following test apparatus is recommended:

- 1 Differential pressure gauge
- 2 Variable pressure source
- 3 Block/bleed and equalizer valves
- 4 Test light or ohmmeter

Determine whether the critical set point occurs on increasing or decreasing differential pressure, and calibrate using the appropriate procedure:

For Critical Set Point on Increasing Differential Pressure

- 1 Connect the continuity test lamp or ohmmeter across the C - Common and NO - Normally Open switching element / contacts.
- 2 Close the bleed valve(s), open the equalizer valve and raise pressure equally on both HI and LO sides to the static pressure that the differential pressure switch will see under normal operating conditions.
- 3 With static pressure stable, close the equalizer valve to isolate the HI side from the LO side.
- 4 Keeping high side pressure steady, slightly open the LO side bleed valve to reduce the LO side pressure (increase differential pressure) until desired differential pressure set point appears on indicator. Close bleed valve to stabilize differential pressure. Check the status of the electrical contacts against the following differential pressure trend graphs. Follow the instructions under the graph that matches the status of the contacts.

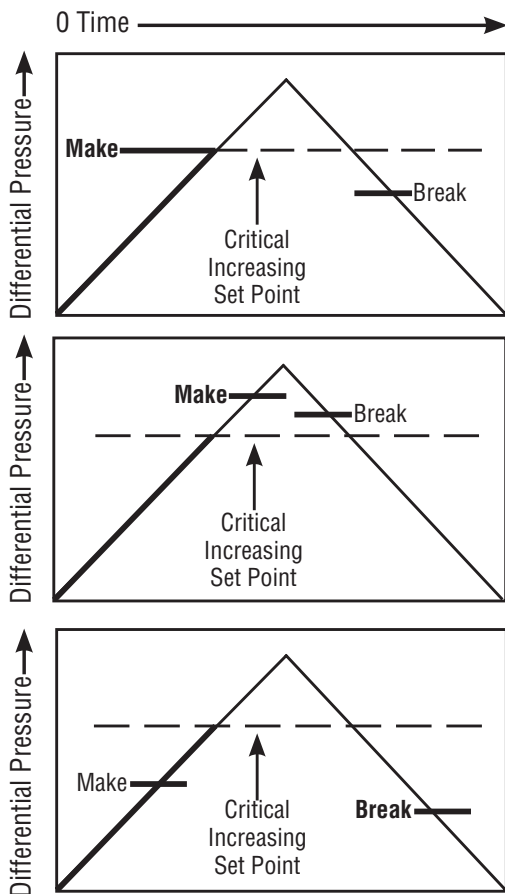

Set Point OK

If contacts **make** precisely at critical increasing differential pressure set point, repeat Steps 2 - 4 as desired to verify calibration. Calibration is complete.

Contacts Open - Set Point Too High

If contacts are **open** when critical increasing differential pressure is reached, turn set point adjustment counterclockwise (out) until contacts make. Repeat Steps 2 - 4.

Contacts Closed - Set Point Too Low

If contacts are **closed** when critical increasing differential pressure is reached, turn set point adjustment clockwise (in) until contacts break. From this point, turn set point adjustment counterclockwise (out) until contacts make. Repeat Steps 2 - 4.

See SOR Form 468 for reference dimension drawings. For certified dimension drawings contact factory.

For Critical Set Point on Decreasing Differential Pressure

- 1 Connect the continuity test lamp or ohmmeter across the C - Common and NO - Normally Open contacts.
- 2 Close the bleed valve(s), open the equalizer valve, and raise pressure equally on both HI and LO sides to the normal operating *high* side pressure.
- 3 With normal HI side pressure stable, close the equalizer valve to isolate the HI side from the LO side.
- 4 Slightly open the LO side bleed valve to reduce LO side pressure (increase differential pressure) *until the normal operating differential pressure appears on the digital indicator*. Close the bleed valve to stabilize differential pressure. Contacts should close (make) by the time normal operating differential pressure is reached. If the contacts are still open at normal operating differential pressure, turn the set point adjustment counterclockwise (out) until the contacts make.
- 5 Keeping the high side pressure steady, slightly open the equalizer valve to increase LO side pressure (decrease differential pressure) until the desired differential pressure set point appears on the digital indicator. Close the equalizer valve to stabilize differential pressure. Check the status of the electrical contacts against the following differential pressure trend graphs. Follow the instructions under the graph that matches the status of the contacts.

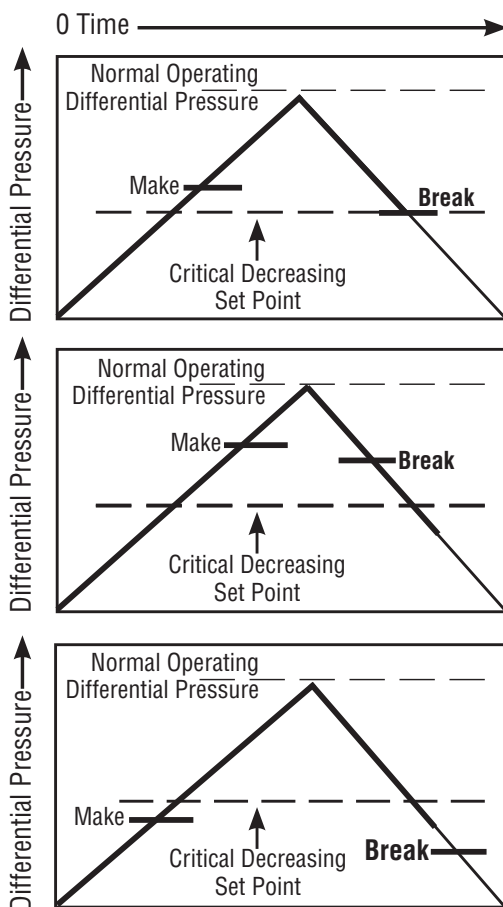

Set Point OK

If contacts break precisely at critical decreasing differential pressure set point, repeat steps **2** - **5** as desired to verify calibration. Calibration is complete.

Contacts Open - Set Point Too High

If contacts are **open** when critical decreasing differential pressure is reached, turn set point adjustment counterclockwise (out) until contacts make. From this point, turn set point adjustment clockwise (in) until contacts break. Repeat Steps **2** - **5**.

Contacts Closed - Set Point Too Low

If contacts are **closed** when critical increasing differential pressure is reached, turn set point adjustment clockwise (in) until contacts break. Repeat Steps **2** - **5**.

ATEX/IECEx Marking Information

For B-Series ATEX/IECEx Certified Models

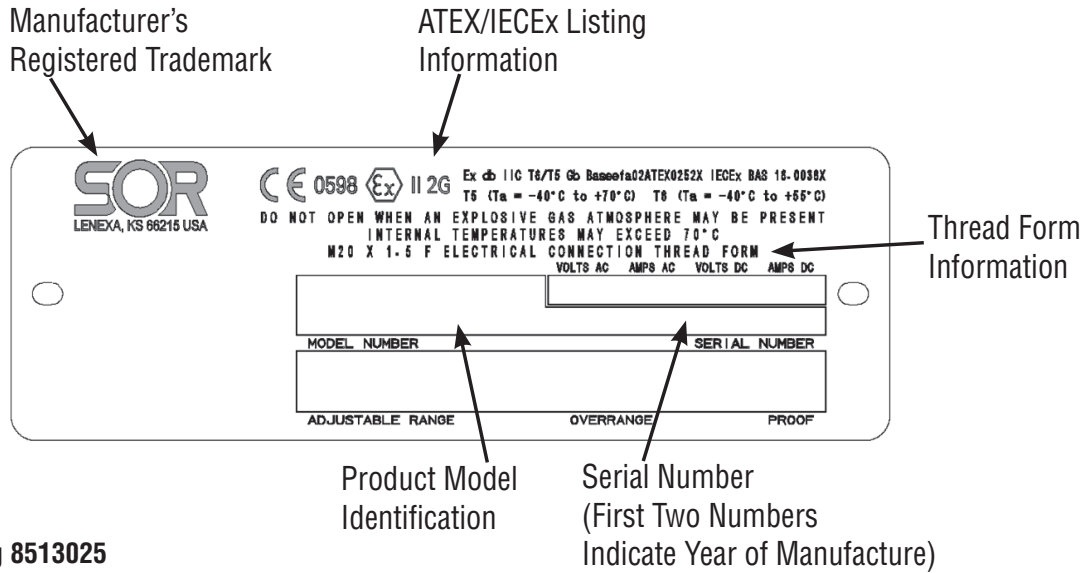

Drawing 8513025

For R-Series ATEX/IECEx Certified Models

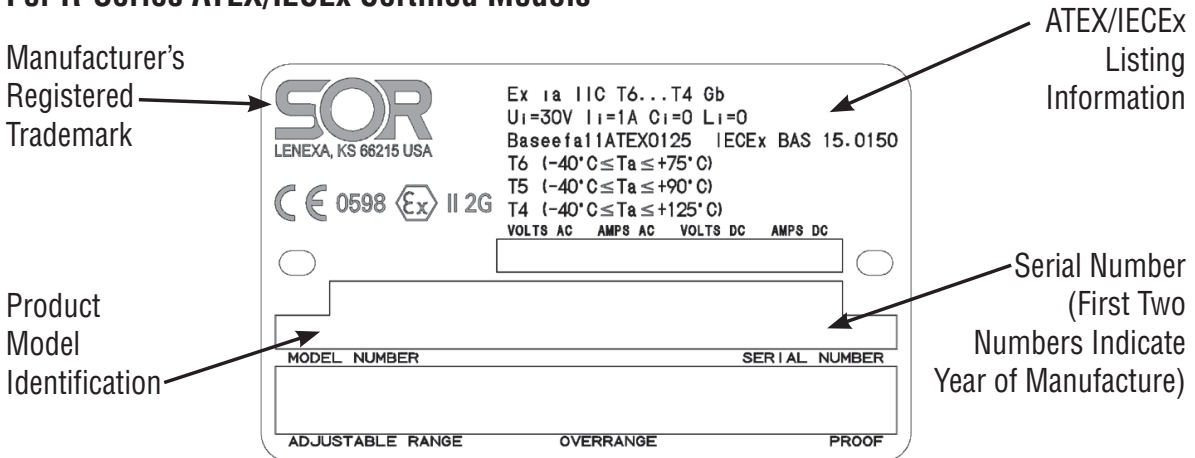



Drawing 0720044

NOTE: The unit conforms to the requirements of clause 6.3.12, EN 60079-11: 2007. The unit is capable of withstanding a 500 Vrms isolation test between circuit and enclosure.

Declaration of Conformity

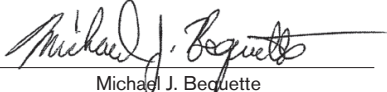
For ATEX Certified Models

EU Declaration of Conformity		CE
Product	B Series Pressure and Temperature Switches	
Manufacturer	SOR Inc.	
Place of Issue	14685 West 105 th Street Lenexa, Kansas 66215-2003 United States of America	
Date of Issue	June 18, 2020	
We declare under our sole responsibility that the above products conform to the following specifications and directives	ATEX Directive (2014/34/EU) Equipment Intended for use in Potentially Explosive Atmospheres EN 60079-0:2012 + A11:2013 IEC 60079-0:2011 EN 60079-1:2014 IEC 60079-1:2014-06	
Carries the marking	 II 2 G Ex db IIC T6/T5 Gb T6 (-40°C ≤ Ta ≤ +55°C) T5 (-40°C ≤ Ta ≤ +70°C)	
Reference document	EC-Type Examination Certificate Baseefa02ATEX0252X Issued May 7, 2003 IECEx BAS 16.0038X Issued June 7, 2016	
ATEX Notified Body	SGS Fimko Oy (Notified Body No. 0598) Takomotie 8 Helsinki, 00380 Finland	
Person responsible	Michael J. Bequette (VP of Engineering)	
 Michael J. Bequette		
Engineered to Order with Off-the-Shelf Speed		

 14685 West 105th Street, Lenexa, KS 66215-2003
913-888-2630 • 800-676-6794 USA • 913-888-0767 FAX

Form 1380 (06.20) ©SOR Inc.

Declaration of Conformity

For ATEX Certified Models

EU Declaration of Conformity		CE
Product	R Series Pressure Switches	
Manufacturer	SOR Inc.	
Place of Issue	14685 West 105 th Street Lenexa, Kansas 66215-2003 United States of America	
Date of Issue	June 18, 2020	
We declare under our sole responsibility that the above products conform to the following specifications and directives	ATEX Directive (2014/34/EU) Equipment Intended for use in Potentially Explosive Atmospheres EN 60079-0:2012 + A11:2013 IEC 60079-0:2011 EN 60079-11:2012 IEC 60079-11:2011	
Carries the marking	 II 2 G Ex ia IIC T6...T4 Gb T6 (-40°C ≤ Ta ≤ +75°C) T5 (-40°C ≤ Ta ≤ +90°C) T4 (-40°C ≤ Ta ≤ +125°C)	
Reference document	EC-Type Examination Certificate Baseefa11ATEX0125 Issued February 16, 2012 IECEx BAS 15.0150 Issued April 19, 2016	
ATEX Notified Body	SGS Fimko Oy (Notified Body No. 0598) Takomotie 8 Helsinki, 00380 Finland	
Person responsible	Michael J. Bequette (VP of Engineering)	

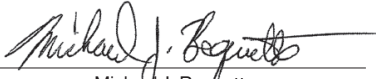
Michael J. Bequette

Engineered to Order with Off-the-Shelf Speed

 14685 West 105th Street, Lenexa, KS 66215-2003
913-888-2630 • 800-676-6794 USA • 913-888-0767 FAX

Form 1539 (06.20) SOR Inc.



14685 West 105th Street, Lenexa, KS 66215 ■ 913-888-2630 ■ 800-676-6794 USA ■ SORInc.com