

General Instructions

These instructions provide information for installation, electrical connection, process connection and calibration of 103 Differential Pressure Switches.

Process pressure is sensed by a diaphragm and piston assembly. The piston responds to differential pressure and moves a lever that is connected to a torsionally stiff cross shaft. One end of the cross shaft is

connected to a lever that is biased by the range spring. The other end has a lever that actuates (deactuates) an electrical switching element.



NOTE: If you suspect that a product is defective, contact the factory or the SOR Representative in your area for a return authorization number. This product should only be installed by trained and competent personnel.

Design and specifications are subject to change without notice.

*For latest revision, go to **SORInc.com***

Table of Contents

Installation	1
SIL Installation	2
Process Connection	2
Electrical Connection.....	3
Special Conditions.....	4
Calibration	5
Dimensions Series 103-212	6
Dimensions Series 103-502, 805	8
ATEX/IECEx Information	10
Declaration of Conformity	11

Installation

This product should only be installed by trained and competent personnel.

Securely mount the pipe kit bracket or base plate as supplied to horizontal member of pipe stanchion, channel rack or flat surface using suitable bolts. The 103 is not position sensitive. It may be mounted in any position.



Use care during installation. Do not inadvertently move the electrical switching element or its housing. Movement of either could disturb the relative positions of internal working parts and alter calibration or render the device inoperative.

Safety Integrity Level (SIL) Installation Requirements

The SOR pressure switches have been evaluated as Type-A safety related hardware. To meet the necessary installation requirements for the SIL system, the following information must be utilized:

- Proof Test Interval shall be one year.
- Units may only be installed for use in Low Demand Mode.
- Products have a HFT (Hardware Fault Tolerance) of 0, and were evaluated in a 1oo1 (one out of one) configuration.

Form 1538 (03.12) ©2012 SOR Inc.

103 Differential Pressure Switch Diagrams

Weathertight — **W1** Housing
ATEX/IECEX Certified Ex ia IIC - **CL** Accessory

Explosion Proof — **AD** Housing
ATEX/IECEX Certified Ex db IIC - **CL** Accessory

- ① Knurled cap over Set Point adjustment
- ② Hi side gaseous process connection 1/4" NPT(F)
- ③ Hi side liquid process connection 1/4" NPT(F)
- ④ Hermetically sealed switching element capsule (18", 18-AWG wire leads)
- ⑤ 1/2" NPT(M) electrical conduit connection
- ⑥ 3/4" NPT(F) electrical conduit connection
- ⑦ Weathertight switching element housing (terminal block under cover)

Process Connection

The high pressure side (marked Hi) has two 1/4" NPT(F) process connections. The low pressure side (marked Lo) also has two 1/4" NPT(F) process connections. For optimum performance, bleed the air or liquid from the switch with ports aligned vertically before placing the switch into service.

Connect the liquid process to the lower ports to bleed gasses from the switch. Connect the gaseous process to the upper ports to bleed liquid from the switch. The switch may then be oriented in any position for switching.

When the process has entrained particles or is considered dirty, both upper and lower connections may be used to create a flushing system to prevent buildup against the diaphragm/piston assembly. Should a pair of process connections be plugged, ensure that plugs are tightened for a leak-free fit.

Electrical Connection

Weathertight Models: Interrupt electrical power. Remove the top cover plate. Terminal block is standard. The insulation is marked C - Common, NO - Normally Open, NC - Normally Closed and G - Ground (earth) when applicable.

Explosion-Proof Models: Hermetically sealed switching element capsule has 18", 18-AWG wire leads color coded and marked C - Common, NO - Normally Open, NC - Normally Closed and G - Ground (earth) when applicable. (See schematic.)

Wiring Lead Code Colors

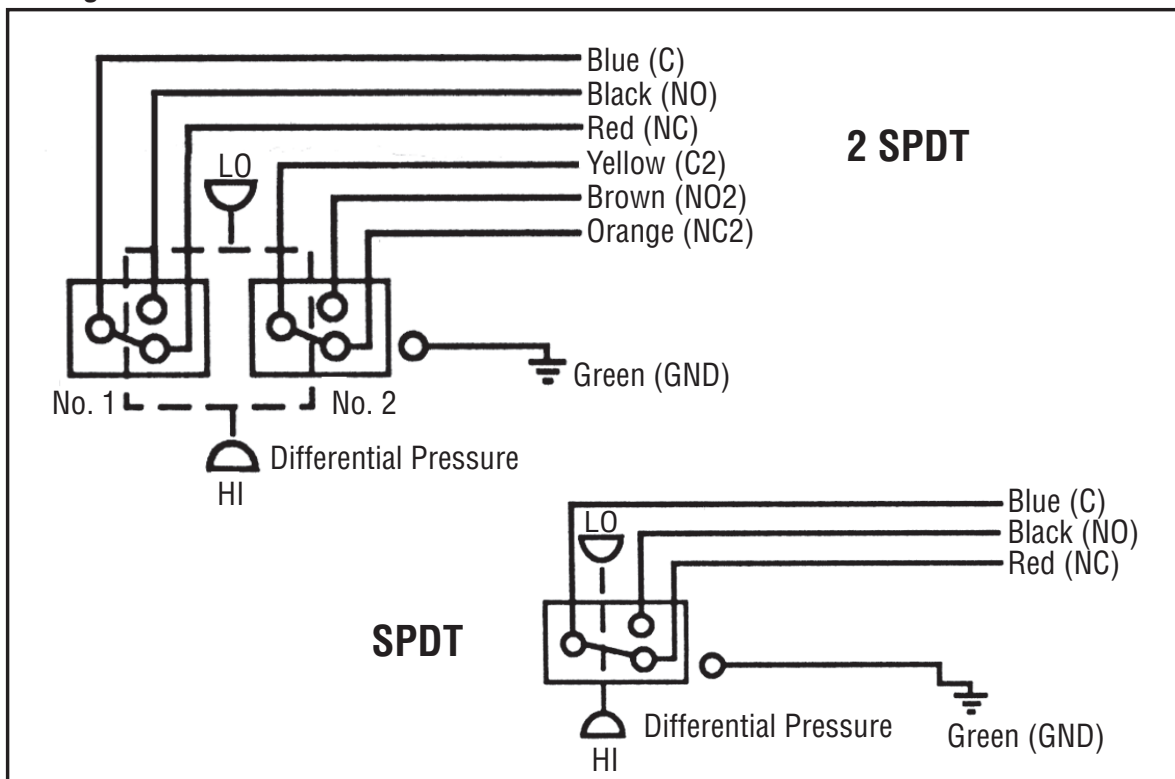

Ensure that the wiring conforms to all applicable local and national electrical codes and install unit(s) according to relevant national and local safety codes.

Special Conditions for Safe Use ATEX/IECEX

- The permanently attached cables must be suitably terminated and protected from impact.
- The apparatus may have a combined nameplate which carries multiple approvals (Intrinsic Safety & Flameproof). The equipment should be marked as to which protection method it is installed as, and shall not be changed or utilized in any other manner than was originally marked by the end user.
- To minimize the risk of electrostatic discharge, clean only with a damp cloth.

NOTE: These circuits are all part of the same IS circuit meeting the requirement of 30V max and 1A max. You cannot connect a zener barrier to C/NO/NC circuit and another barrier to C2/NO2/NC2 circuit unless the combination of the two barriers is intrinsically safe and is less than 30V and 1A.

NOTE: For IS, there must be no connection to GND if the switch circuit is connected to a shunt zener diode safety barrier.

Calibration

Coarse Calibration

Device calibrated without reference to system (static) pressure (Lo side vented). Test apparatus:

- Pressure gauge
- Variable pressure source
- Test light or ohmmeter

- ① Remove weathertight knurled cap.
- ② Insert a 5/32 Allen hex wrench into Set Point adjustment.
- ③ Connect a test light or ohmmeter to C – Common and NO – Normally Open. W1 - Terminal block is accessible under noted cover. AD - This model supplied with color coded and marked wire leads.
- ④ Increase pressure to the desired Set Point on Increasing pressure.
- ⑤ Turn the hex wrench clockwise (in) to increase Set Point and counterclockwise (out) to decrease Set Point. Note the actuation, deactuation by test light or ohmmeter.
- ⑥ For Set Point on Decreasing pressure, decrease pressure to the desired Set Point and repeat Step 5.
- ⑦ Remove the hex wrench and replace weathertight cap.

Precise Calibration

The device is calibrated with reference to system (static) pressure. Performance is enhanced when calibration is accomplished under simulated system pressure profile or as it is intended to be used in actual service. Test apparatus:

- Differential pressure gauge
- Variable pressure source
- Block/bleed and equalizer valves
- Test light or ohmmeter

- ① Remove the weathertight knurled cap.
- ② Insert 5/32 Allen hex wrench into Set Point adjustment.
- ③ Connect test light or ohmmeter to C–Common and NO – Normally Open. W1 - Terminal block is accessible under noted cover. AD - This model supplied with color coded and marked wire leads.
- ④ Increase pressure equally on Hi and Lo sides to desired system (static) operating pressure (equalizer valve open).
- ⑤ To adjust Set Point on Increasing Differential Pressure: Close equalizer valve and bleed Lo side until desired pressure appears on indicator and Set Point is verified by test light or ohmmeter. Turn hex wrench clockwise to increase Set Point and counterclockwise to decrease Set Point. Note actuation, deactuation by test light or ohmmeter.
- ⑥ To adjust Set Point on Decreasing Differential Pressure: Differential Pressure must be at or above Increasing Set Point, then slightly open equalizer valve until desired decreasing pressure appears on indicator and Set Point is verified by test light or ohmmeter. Perform Step 5 above as necessary.
- ⑦ Remove Allen wrench and replace weathertight cap.



Do not remove other covers or attempt to adjust other parts of the mechanism. All have been precisely positioned at the factory and should not be moved in the field.

Dimensions — Series 103-212

Dimensions in this literature are for reference only. Contact the factory for certified drawings for a particular model number.

W1 Non-Hazardous Service (Weathertight)

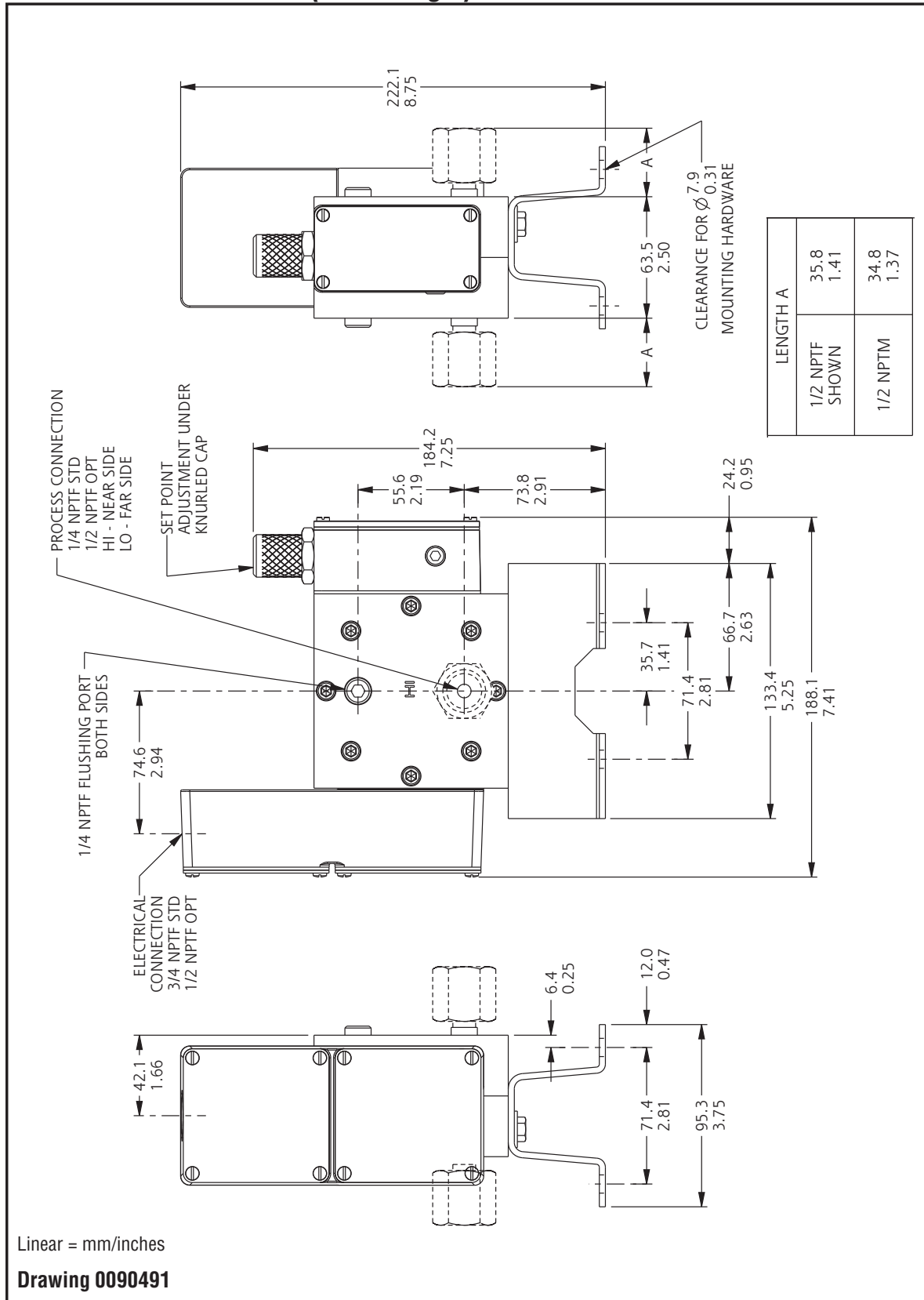

Linear = mm/inches

Drawing 0090491

AD Hazardous Service (Weathertight)

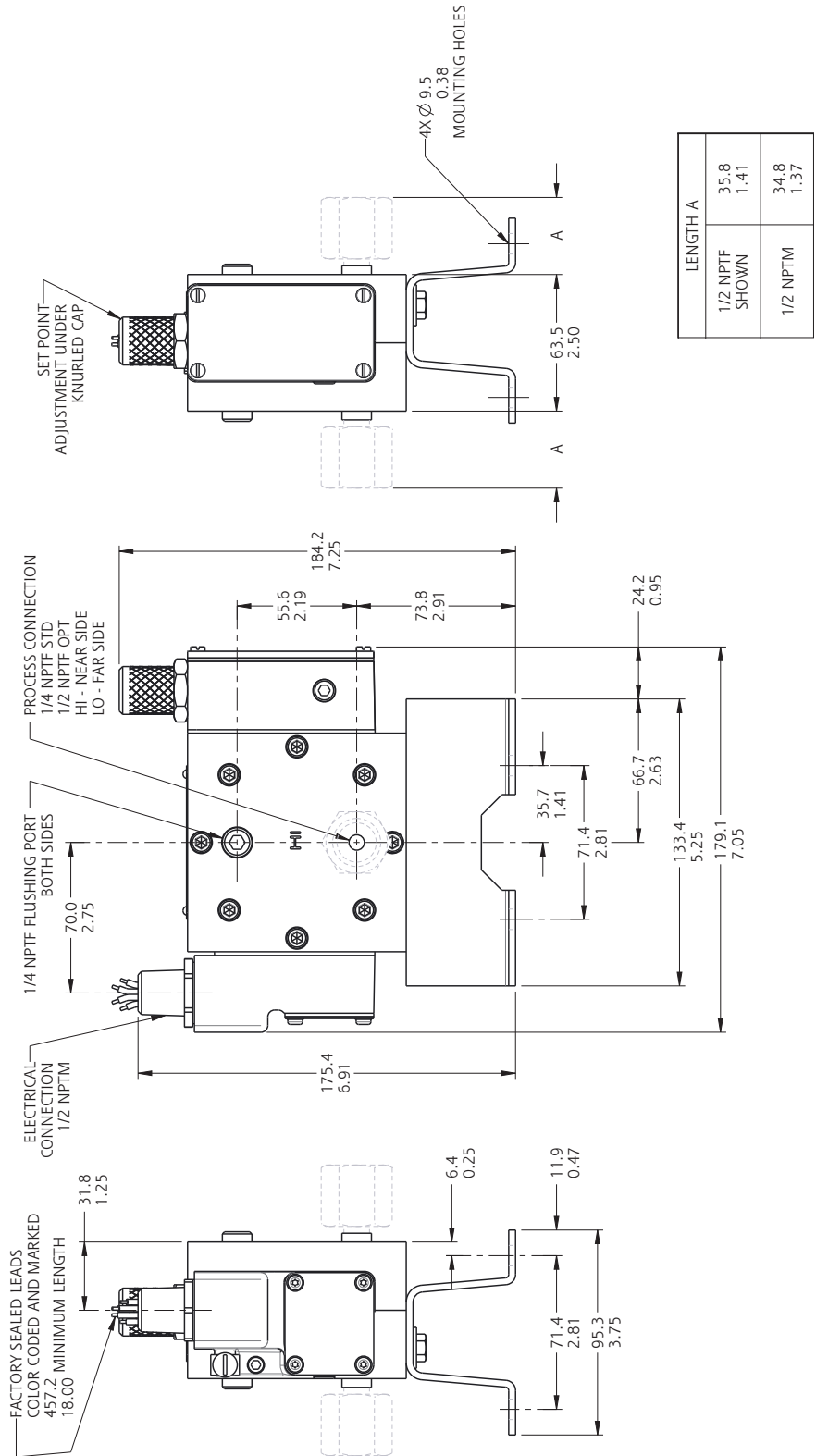

Linear = mm/inches

Drawing 0090493

Dimensions — Series 103-502, 805

Dimensions in this catalog are for reference only. Contact the factory for certified drawings for a particular model number.

W1 Non-Hazardous Service (Weathertight)

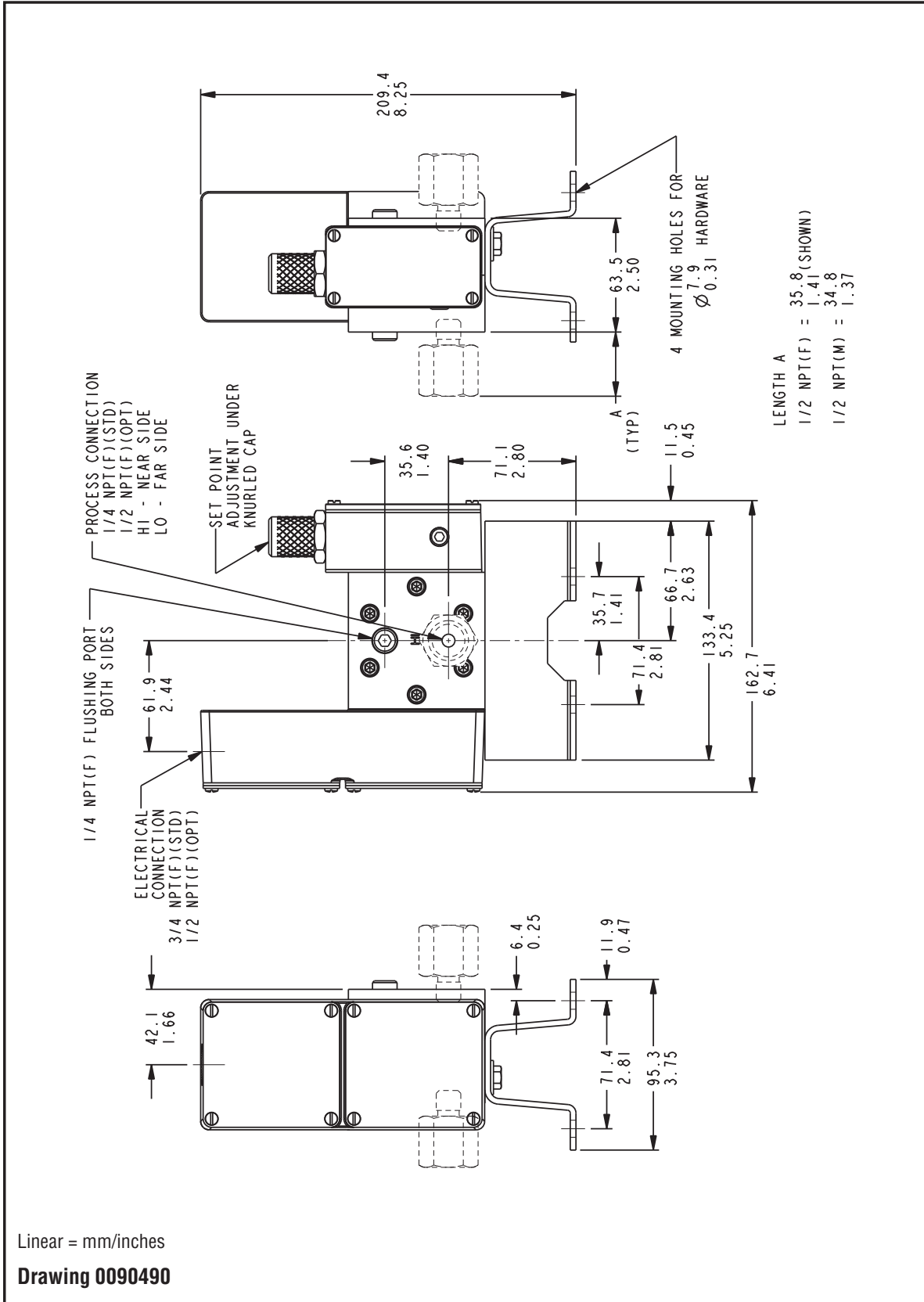

Linear = mm/inches

Drawing 0090490

AD Hazardous Service (Weathertight)

LENGTH A	
1/2 NPTF SHOWN	35.8 1.41
1/2 NPTM	34.8 1.37

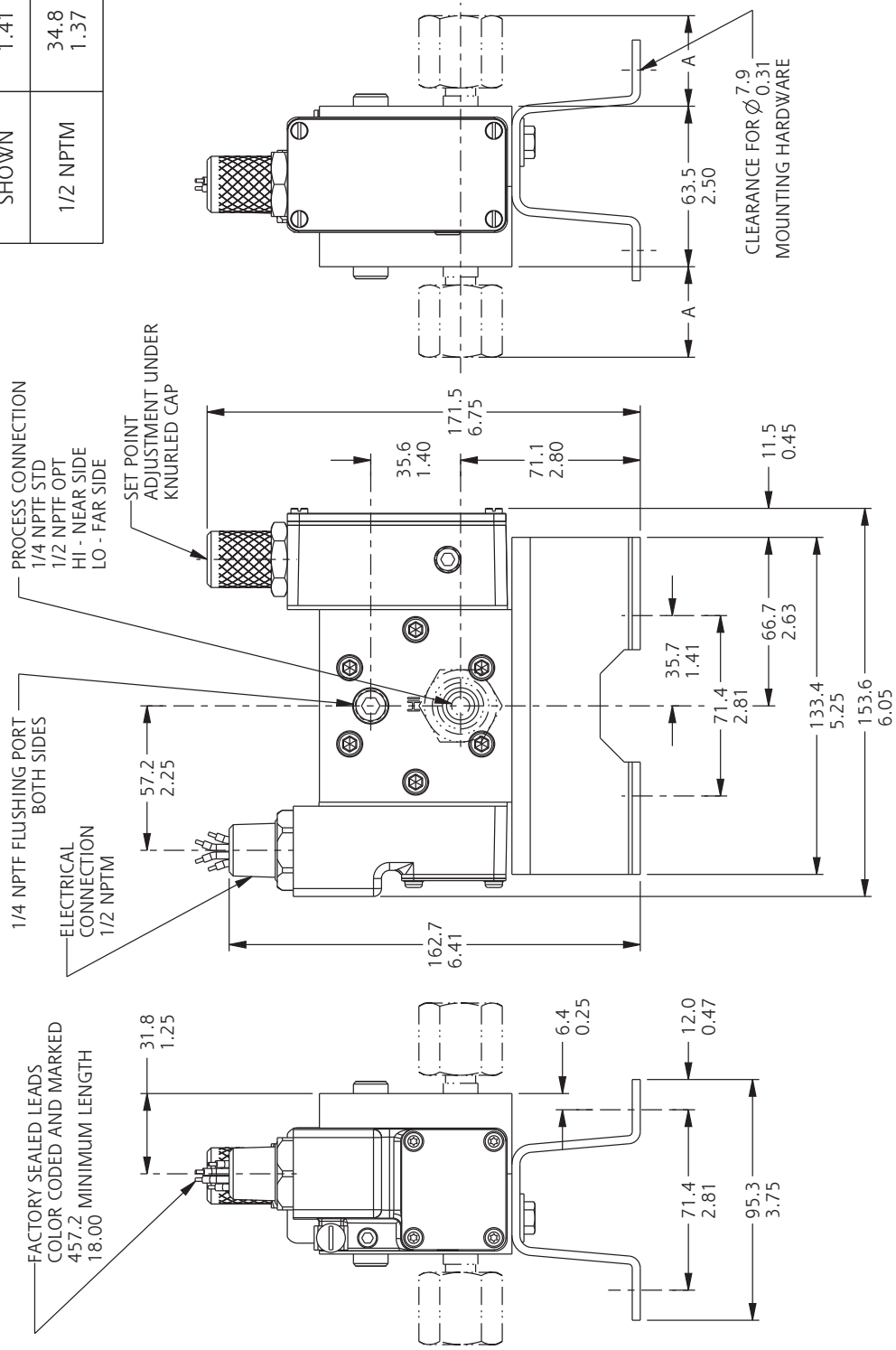

Linear = mm/inches

Drawing 0090492

General Information for ATEX/IECEX-Certified Models

Sample Nameplate

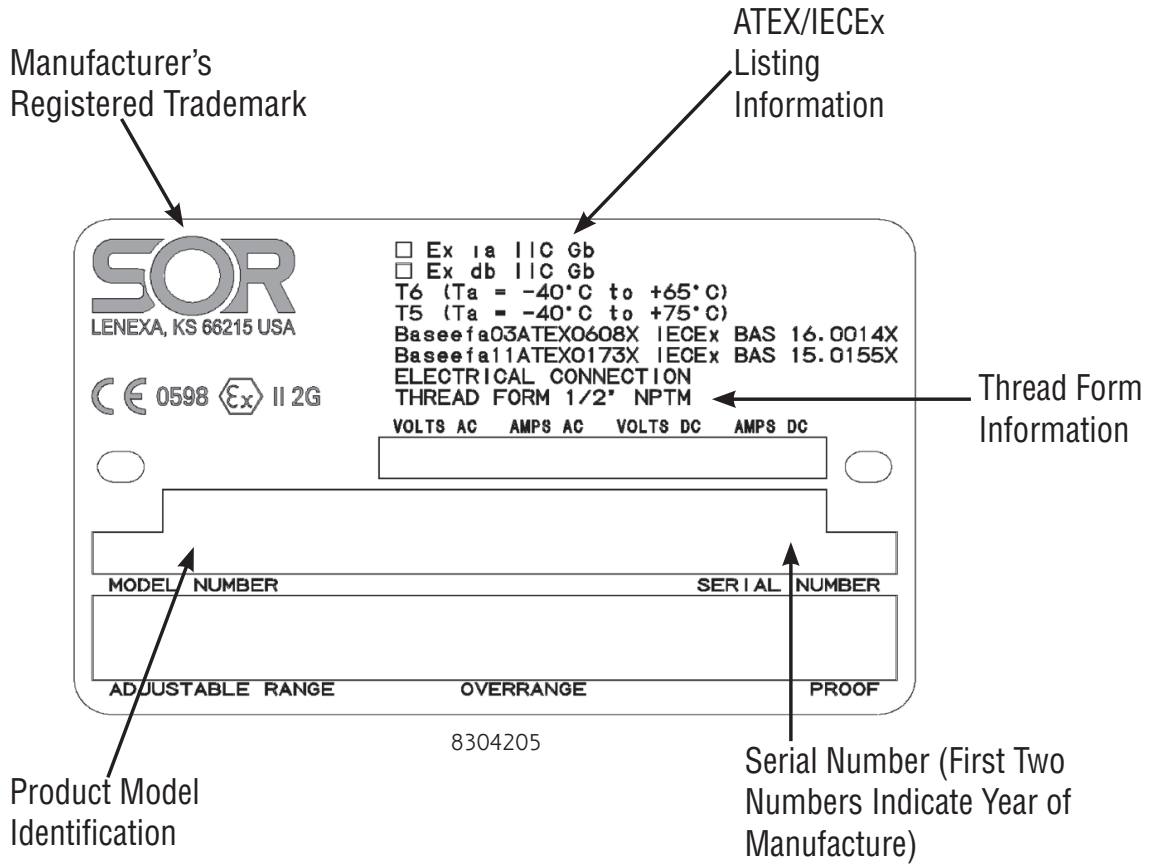

Drawing 8304205

Declaration of Conformity

For ATEX/IECEx Certified Models

EU Declaration of Conformity

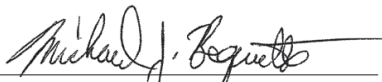

Product	A Series 102 or 103 Differential Pressure Switch
Manufacturer	SOR Inc.
Place of Issue	14685 West 105 th Street Lenexa, Kansas 66215-2003 United States of America
Date of Issue	June 18, 2020
We declare under our sole responsibility that the above products conform to the following specifications and directives	ATEX Directive (2014/34/EU) Equipment Intended for use in Potentially Explosive Atmospheres EN 60079-0:2012 + A11:2013 IEC 60079-0:2011 EN 60079-1:2014 IEC 60079-1:2014-06 EN 60079-11:2012 IEC 60079-11:2011
Carries the marking	 II 2 G Ex db IIC T6/T5 Gb Ex ia IIC T6/T5 Gb T6 (-40°C ≤ Ta ≤ +65°C) T5 (-40°C ≤ Ta ≤ +75°C)
Reference document	EC-Type Examination Certificates Baseefa03ATEX0608X Issued October 31, 2003 Baseefa11ATEX0173X Issued March 28, 2012 IECEx BAS 16.0014X Issued May 18, 2016 IECEx BAS 15.0155X Issued August 5, 2016
ATEX Notified Body	SGS Fimko Oy (Notified Body No. 0598) Takomotie 8 Helsinki, 00380 Finland
Person responsible	Michael J. Bequette (VP of Engineering)

Michael J. Bequette

Engineered to Order with Off-the-Shelf Speed

 14685 West 105th Street, Lenexa, KS 66215-2003
913-888-2630 • 800-676-6794 USA • 913-888-0767 FAX

Form 1383 (06.20) ©SOR Inc.



14685 West 105th Street, Lenexa, KS 66215 ■ 913-888-2630 ■ 800-676-6794 USA ■ SORInc.com

12/12 Registered Quality System to ISO 9001

Form 391 (07.21) ©SOR Inc.